

Operation Manual

Conductivity / TDS / Salinity

Transmitter / Controller
CON2000/ CON3000/ CON5000/ CON5500

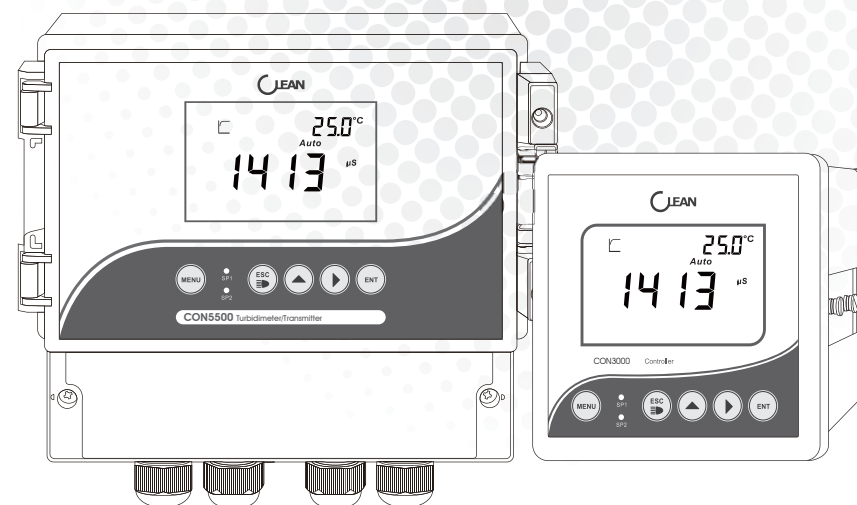

Conductivity / TDS / Salinity

Controller / Transmitter (CON2000/CON3000/CON5000/CON5500)

www.cleaninst.com

Customer Service: CS@cleaninst.com

CLEAN INSTRUMENTS

2006, No.511 Tianmu W. Rd. Shanghai 200070, China
11F No.25,Siwei St., Zhonghe Dist.,New Taipei City 23570, Taiwan

www.cleaninst.com

TABLE OF CONTENTS

1 PREFACE	03
1.1 Before Use	03
1.2 In Use	03
1.3 Safety	03
2 PRODUCT OVERVIEW	04
2.1 Product Features	04
2.2 Technical Parameters	05
2.3 Measurement & Control System	06
2.4 Appearance	07
2.4.1 Display	07
2.4.2 Display Character Table	07
2.4.3 Key Panel	08
2.4.4 LED Indicator	09
2.5 Menu Preview	10
3 INSTALLATION	11
3.1 Installation	11
3.2 Connection Diagram	12
4 CALIBRATION	13
4.1 Conductivity Calibration	13
5 SET UP	15
5.1 P01 Cell Constant (K)	15
5.2 P02 Measurement mode	16
5.3 P03 Measurement Range	16
5.4 P04 Temperature Compensation Base	17
5.5 P05 Conductivity Temperature Factor	17
5.6 P06 TDS Factor	18
5.7 P07 Salinity Factor	18
5.8 P08 Temperature Input & Offset	19
5.09 P09 Relay 1 (SP1)	20
5.10 P10 Relay 2 (SP2)	20
5.11 P11 Relay 3 (SP3)	21

Only for 5000/5500

8.1 Measurement Range of Conductivity Electrode

Cell Constant	Measurement Range	Resolution
K=0.01cm ⁻¹	0.000-4.000 μS/cm	0.001 μS/cm
	0.00-40.00 μS/cm	0.01 μS/cm
	0.0-400.0 μS/cm	0.1 μS/cm
K=0.1cm ⁻¹	0.00-40.00 μS/cm	0.01 μS/cm
	0.0-400.0 μS/cm	0.1 μS/cm
	0-4000 μS/cm	1 μS/cm
K=1cm ⁻¹	0.0-400.0 μS/cm	0.1 μS/cm
	0-4000 μS/cm	1 μS/cm
	0-40.00 mS/cm	0.01 mS/cm
K=10cm ⁻¹	0-4000 μS/cm	1 μS/cm
	0-40.00 mS/cm	0.01 mS/cm
	0-400.0 mS/cm	0.1 mS/cm

5.12 P12 Current Output Only for 5000/5500 22
 P-13 P13 RS485 Output 22
 5.14 P14 Password 23
 5.15 P15 Factory Defaults 23
 5.16 Current Setup Status Review 24

6 PROTOCOL 25

7 GENERAL INFORMATION 30

7.1 Warranty 30
 7.2 Return Of Malfunction Instruments 30
 7.3 Guidelines Or Returning Unit For Repair 30

8 APPENDIX 31

8.1 Measurement Range of Conductivity Electrode 31
 8.2 Factory Defaults 31

Model and Function

	CON2000	CON3000	CON5000	CON5500
Cell Constant (K)	P01 Page15	P01 Page15	P01 Page15	P01 Page15
Measurement mode	P02 Page16	P02 Page16	P02 Page16	P02 Page16
Measurement Range	P03 Page16	P03 Page16	P03 Page16	P03 Page16
Temperature Compensation Base	P04 Page17	P04 Page17	P04 Page17	P04 Page17
Conductivity Temperature Factor	P05 Page17	P05 Page17	P05 Page17	P05 Page17
TDS Factor	P06 Page18	P06 Page18	P06 Page18	P06 Page18
Salinity Factor	P07 Page18	P07 Page18	P07 Page18	P07 Page18
Temperature Input & Offset	P08 Page19	P08 Page19	P08 Page19	P08 Page19
Relay 1 (SP1)		P09	P09 Page20	P09 Page20
Relay 2 (SP2)		P10	P10 Page20	P10 Page20
Relay 3 (SP3)			P11 Page21	P11 Page21
Current Output	P09 Page22	P11 Page22	P12 Page22	P12 Page22
RS485 Output			P13 Page22	P13 Page22
Password	P10 Page23	P12 Page23	P14 Page23	P14 Page23
Factory Defaults	P11 Page23	P13 Page23	P15 Page23	P15 Page23

8.2 Factory Defaults

Instrument Constant	Measurement Range	Initial value
Cell constant type	0.01,0.1,1,10	1.0
Base temperature	15-35 °C	25 °C
Conductivity variance ratio per temperature	0.00-10.00%	2.00%
TDS factor	0.40-1.00	0.50
Salinity factor	0.48-0.65	0.65
Temperature bias	±10°C of the indicated temperature	0.0 °C
Password	4 digits	0000

7.1 Warranty

CLEAN Instruments warrants this product to be free from significant deviations in material and workmanship for a period of one year from the date of purchase. If repair is necessary and has not been the result of abuse or misuse within the warranty period, please return to CLEAN Instruments and amendment will be made without any charge. CLEAN Instruments Customer Service Center will determine if product problem is due to deviations or customer abuse. Out of warranty products will be repaired on a charge basis.

7.2 Return Of Malfunction Instruments

Authorization must be obtained from CLEAN Instruments Customer Service Center to issue a RIR number before returning items for any reason. When applying for authorization, please include date requiring the reason of return. Instruments must be carefully packed to prevent damage in shipment and insured against possible damage or loss. CLEAN Instruments will not be responsible for any damage resulting from careless or insufficient packing.

Warning: Damage as a result of inadequate packaging is the User / distributor's responsibility. Please follow the guidelines below before transporting.

7.3 Guidelines Or Returning Unit For Repair

Use the original packaging material if possible, when transporting back the unit for repair. Otherwise wrap it with bubble pack and use a corrugated box for better protection. Include a brief description of any faults suspected for the convenience of Customer Service Center, if possible. If there are any questions, feel free to contact our Customer Service Center or distributors.

1.1 Before Use

Thank you for selecting CLEAN Controller/Transmitter. Although the Controller / Transmitter use advanced technology and meet the requirements of current safety rules, improper use can still threaten the safety of users, and / or cause harmful influences to factory and other equipments. Therefore, before using the controller / transmitter, relevant person must read and understand contents of this operation manual.

Operation manual should be kept accessible within the person who use the controllers / transmitters.

If you have problems which are not mentioned or can not be explained in this manual, please contact CLEAN local customer service center. They will be very glad to help you.

1.2 In Use

On any unmentioned use or the use that contradict with the technical parameters the operators should bear the responsibility.

Other conditions of right use include:

- Remarks and requirements stated in operation manual.
- Local safety regulations on safe operation.
- Information and warning of products that are used together with the transmitters in the contract. (chassis, electrode, etc.)
- Required operating environment and working condition.

1.3 Safety



The transmitters may only be carried out by trained experts.

Unqualified Transmitters should not be installed and used.

The transmitters should be used under the required working condition.

The transmitters should not be opened and repaired by clients themselves.

Modified transmitters should not be used. Manufacturers and suppliers do not bear responsibility for the damage and lost caused by modifying instruments without permission. Clients should bear all the risks.

This instrument is IP65 rated. Please use waterproof cable glands when you connect the cable. Also, please loose it when you open the cover. After connecting the cable, please tighten the cable conductor according to the following instruction with cable ties, or it will cause danger such as cable conductor or interface falls off when open the cover.



Please make sure to cut the power off when you open the cover to carry on any operation.

2 PRODUCT OVERVIEW

2.1 Product Features

CLEAN CON3000/CON5000/CON5500 Controller/Transmitter is used to measure Conductivity, TDS, Salinity and temperature value.

The transmitters can be panel-mounted. They can be used as monitor in water treatment, controller in electrolytic water cleaning, in chemical industry, in food process, in cleaning water or waste water treatment and in neutralization process.

- Standard 1/4 DIN casing ,easy installation.
- IP65 rated, waterproof and anti-gas, applicable in extreme conditions.
- High protection against electromagnetic interference.
- Menu-driven program that simplifies set-up.
- Built-in memory backup to ensure that setup parameter and calibration information are not erased or power -off condition.
- Scaleable isolated 4-20mA Outputs
- Temperature value offset adjustment.
- Two relay circuits, users can select high-low control freely. Separately adjustable high and lowset-point hysteresis (dead bands) prevent chattering of relays around the set points.
- LED indicators monitor control status from a distance.
- Large LCD, with high luminance LED backlight.

Analyze on the data part:

Byte	1	2	3
Analyze	Unit type: 2 is for conductivity	Sensor type: 1 is the 0.01 sensor, 2 is the 0.1 sensor, 3 is the 1.0 sensor, 4 is the 10.0 sensor	Control type: 1 is the conductivity, 2 is the TDS, 3 is the Salinity
Byte	4,5,6,7	8,9	10,11
Analyze	4,5 is the integer data in the measuring range, 6 is the decimal point place, 7 is the unit	Base temperature	Temperature compensation factor
	12	13	14
	TDS Factor	Salinity	Temperature compensation type
	15,16		
	Temperature bias		

Note: In the ORH mode condition, only byte 1 is valid, other bytes are all 0.

Unit comparison table:

Data	0	1	2	3	4	5	6
Unit	mV	nA	uA	mA	Ω	KΩ	MΩ
Data	7	8	9	10	11	12	13
Unit	uS	mS	S	PH	°C	°F	Ug/L
Data	14	15	16	17	18	19	20
Unit	Mg/L	g/L	ppb	ppm	ppt	%	mbar
Data	21	22					
Unit	bar	mmHg					

3) Returned setting data (public), suppose the unit ID code is 01

01	03	XX	Data	CRC value
Unit ID code	command	Number of data 1 byte (28 bytes)	28 bytes	The last 2 bytes

The definition of data part:

Relay 1:

1,2	3	4	5,6	7	8
ON integer	Decimal point	unit	OFF integer	Decimal point	unit

Relay 2:

9,10	11	12	13,14	15	16
ON integer	Decimal point	unit	OFF integer	Decimal point	unit

Relay 3:

17	18	19,20
Relay type	Cleaning second(s)	Cleaning interval(hours) 2bytes integer

Relay 3:

21,22	23	24	25,26	27	28
The transmitter 4mA corresponding value (2bytes integer)	Decimal point	unit	The 20mA corresponding value(2bytes integer)	Decimal point	unit

4) Returned setting data (private), suppose the unit ID code is 01

01	03	XX	Data	CRC value
Unit ID	Command	Number of the data		The last 2 bytes

2.2 Technical Specifications

Model		CON2000	CON3000	CON5000	CON5500
Conductivity	Range	0.000 μ S/cm-400.0 mS/cm			
	Resolution	0.001 μ S/cm-0.1 mS/cm			
	Accuracy	\pm 0.5% F.S.			
	Cell Constant	K=0.01,0.1,1.0,10.0			
	Reference Temp.	15.0-25.0 $^{\circ}$ C			
	Temperature Factor	0.00-4.00%			
Salinity	Range	0.0-400.0 g/L			
	Resolution	0.1 g/L			
	Accuracy	\pm 0.5% F.S.			
	SAL Factor	0.65			
TDS	Range	0.000 ppm-400.0 ppt			
	Resolution	0.001 ppm-0.1 ppt			
	Accuracy	\pm 0.5% F.S.			
	TDS Factor	0.40-1.0			
Temperature	Range	-10.0-110.0 $^{\circ}$ C			
	Resolution	0.1 $^{\circ}$ C			
	Accuracy	\pm 0.3 $^{\circ}$ C			
	Temperature Sensor	Pt1000			
Signal Output/ load	TEMP.Compensation	Automatic			
	Signal Output	4-20 mA (Adjustable)			
	Current Accuracy	\pm 1% F.S.			
	Load	< 500 Ω			
Data interface:	RS485				MODBUS Protocol
Relay Output	On/Off			2 SPST Relays	
	Output			2.5A 230 VAC	
	Cleaning/Alarm Relays			1 \times 2.5A	
Others	Power	24 VDC			
	Working Temperature	0-60 $^{\circ}$ C			
	Humidity	< 85%			
	IP Rated	IP65			
	Installation	Panel Mounting			Wall Mounting
	Dimensions	(H \times W \times D)108 \times 108 \times 158 mm			160 \times 188 \times 108
	Panel Cut Size	94.5 \times 94.5 mm			
Weight	0.5 kg			0.7 kg	

2.3 Measurement & Control System

Typical measurement system includes:

- Conductivity on-line transmitter
- Conductivity electrode with Pt1000 temperature sensor
- Suitable conductivity measurement cable
- Immersion, flow or processing parts
- Terminate control parts, e.g. Pump or valve
- 4~20mA output current to connect with recording instrument

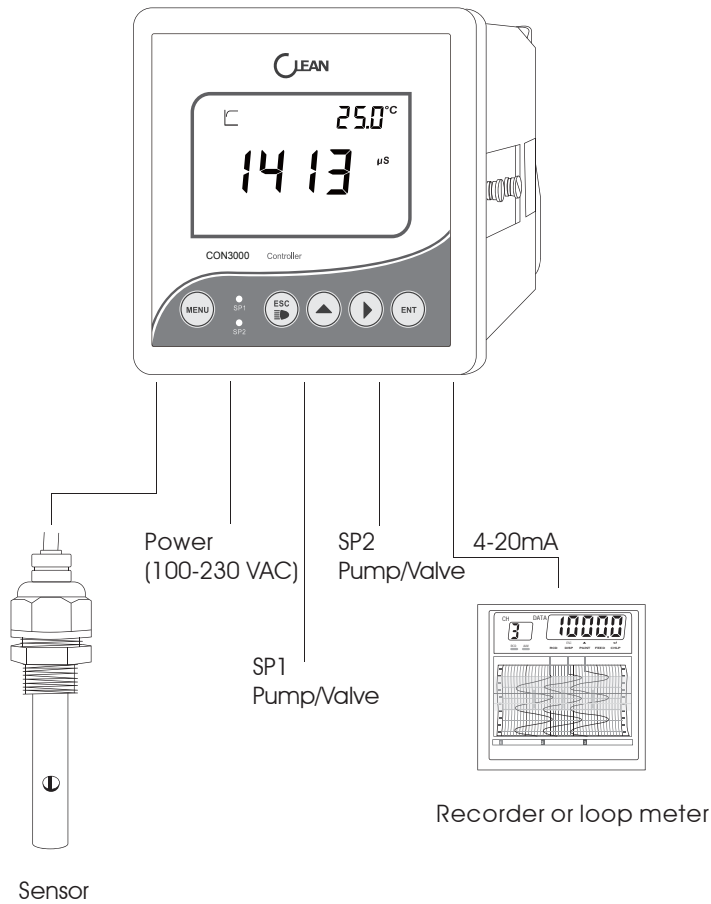

Analyze on the data:

Byte	1,2	3	4
Analyze	The conductivity value integer	decimal point	unit

Note: 7FFF is outranged, 8000 is below is range.

Decimal point of the third byte: 02 is 2 decimal places,00 is without decimal point

Unit of the fourth byte: 07 is uS,08 is mS,14 is mg/L,15 is g/L

Byte	5,6	7	8
Analyze	The temperature value integer	Decimal point	unit

Temperature value: 7FFF is outranged, 8000 is below is range.

Byte 7: The decimal point of temperature 01 is a 1 decimal place.

Byte 8: 11 is °C,12 is °F

Byte 9,10 ,11,12 are reserved bytes.

Byte 13 and 14 are the current transmission output value (integer). The default is 2 decimal places, unit is mA.

Byte 15 is the status of the Relays, 0 is disconnect, 1 is closed. The first 5 figures are independent bits. The sixth figure is Relay 3,the seventh figure is Relay2, the eighth figure is Relay 1.

2) Returned Calibration data: suppose the ID code of the unit is 01

01	03	0F	Data	CRC value
Unit ID	Command	1 byte (fix the number of data as 15 here)	15 bytes data	The last 2 bytes

The definition of data part:

Calibration status of Byte 1:

Calibration status: the first 7 figures are independent bits. The eighth figure is the marker bit. 0 refers to without calibration,1 refers to calibration done.

Byte 2 and 3 are useless bits.

Byte 4 and 5 are the Conductance electrode slope,Byte 6 and 7 are the useless bits.

Byte 8,9,10,11,12,13,14 are reserved bytes.

5. Analyze on the error data from the Console computer

1) No responding from Console computer

- a. Wrong sending address from the Host computer
- b. Receive time out. Timing when the Console computer receives the first data. The receiving will stop if the received data is less than the required command bytes (5 bytes) when the second system is interrupted.
- c. Host computer command bytes exceeding. Command will be invalid if the received command bytes in the receiving time are more than required. If the command sending from the Host computer is too frequent also leads to the same problem. Suggest the interval of the Host computer command sending be more than 0.5 seconds.

2) Returned Error code from the Console computer

Returned Error code from the Console computer is 5 bytes. The command from the Host computer and the Error code share the same beginning of 8, for example:

Address	Host computer command +0X80	Error code	CRC calibration
1 byte	1 byte	1 byte	2 bytes

The Error code can be classified as the following 4 circumstances:

a. Error in command: The command from the Host computer is for example 01 05 01 E2 90 instead of 03.

The Console computer will return 01 05+80 81 82 F0

Command Error—01 85 81 82 F0

b. Error in Command object. Available command object: 01. 02.03.04. If 01 03 07 61 32

the console computer will return: 01 03 +80 82 C1 51

Command object Error: 01 83 82 C1 51

c. Error in CRC calibration code: If 01 03 01 AA BB(correct code: 01 03 01 E1 30)

the console computer will return: 01 03 +80 83 00 91

CRC calibration code Error: 01 83 83 00 91

d. Unit not in the measurement condition, specially refers to when there is no mistake from the Host computer command, however, the Console computer is not in the correct measurement condition cause the failure of uploading the measurement results. For example:

Console computer returns: 01 03+80 80 40 90

Unit not in the measurement condition: 01 83 80 40 90

6. Analyze on the correct data from the Console computer

Note: The lower byte is behind the high byte in all returned integer data.

The returned data from the Console computer can also be classified in 4 circumstances as the Host computer.

1) Returned floating data: suppose the Unit ID code is 01

01	03	Number of data	Data	CRC value
Unit ID	Command	1 byte (fix the number of data as 15 here)	15 bytes data	The last 2 bytes

2.4 Appearance

2.4.1 Display



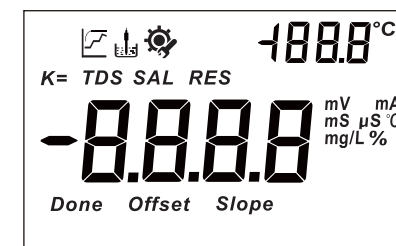

- 1 Measuring Status-Calculating
- 2 Measuring Status-Stable Value
- 3 Electrode inserted display
- 4 Setup display
- 5 **Offset** - Electrode Offset
- 6 **Slope** - Electrode Slope
- 7 **Done** - Calibration Done
- 8 **mS,uS,°C,mg/L,ppm,ppb** - Unit of Measurement
- 9 **TDS** - Total Dissolved Solids
- 10 **SAL** - Salinity
- 11 **K=** - Cell Constant



2.4.2 Display Character Table

SEN	Sensor	DEF	Factory Default
UNT	Measurement Parameter	OVER	Over Range
CON	Conductivity	UNDR	Under Range
TDS	TDS	OFF	Offset
SAL	Salinity	SL1	Slope 1
RAN	Range	SL2	Slope 2
TRF	Temperature Base	SAVE	Save
COE	Coefficient	ERR	Error
TC	Temperature	ON	On
TH10	TC10K	OFF	Off
PT	Pt1000	NO	NO
TOFS	Temperature Offset	FULL	Full Data Storage
SP1	Relay 1	YES	YES
SP2	Relay 2	OUR	Temperature Over Range
CUR	4-20mV Current Output	UDR	Temperature Under Range
COD	Password	P-	Menu Item

2.4.3 Key Panel

Key	Description
	Menu Key In measuring status, press the key once into Calibration mode In calibration or Set up mode, Press the key back to measuring status
	Escape Key Press and back to previous screen display in Calibration or Set Up mode Back light on and off switch in measurement status
	Up Arrow Key In measuring status, press the key into "Set Up Status Review" mode, press again to check each set up status. In SET UP mode, press to select items and to adjust set value. In Menu mode, act as forward cycle key
	Right Arrow Key In measuring status, press the key to change measurement mode In SET UP mode, press to select digits of value In Menu mode, act as backward cycle key
	Confirm Key Confirm the selection

2.4.4 LED Indicator

LED Indicator

SP1/ SP2 LED light-on shows the relevant relay is in working status.

6 PROTOCOL

1. General Introduction

The unit adopts the RS-485 Modbus Protocol. The communication distance is as long as 1200m by merging 1-200 units in one communication line. Range of the ID code can be from 001-200.

Communication baud rate range 1200, 2400, 4800,9600,19200.

Data format can refer to the Modbus RTU format.

2. Composition of the communication command: Command from the Host computer

Console computer address(ID code)	Command code	Command object	CRC (Calibration)
1 byte	1 byte	1 byte	2 bytes(High in front)

3. Console computer address and the unit (ID code of the Console computer)

Command code: 03 is fixed here to read the contents from the register

Command object: the data format of the Host computer need to read from

Command	Object	Explanation of the data
01	Floating data (measured data)	The measured data, include the output current and the status of the Relays
02	Calibration data	The zero point, slope, calibration point, etc of the electrode after the calibration done
03	Parameter setting 1	The public part of the setup data
04	Parameter setting 2	The exclusive part of different units

4. The complete command from the Host computer (suppose the Console computer address is 01)

Console computer address	Command Code	Command Object	CRC Calibration	Explanation of the data
01	03	01	E1 30	reading the floating data
01	03	02	A1 31	reading the calibration data
01	03	03	60 F1	reading the parameter setting(public)
01	03	04	21 33	reading the the parameter setting(private)

5.14 Current Setup Status Review

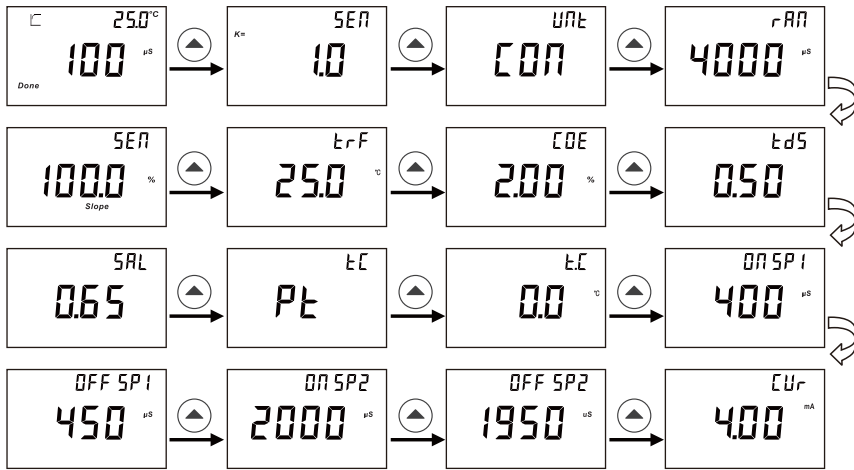

- In measurement mode, press ▲ key to review each setting from P-01 to P-13. Press **MENU** key to go back to measurement mode.

2.5 Menu Preview

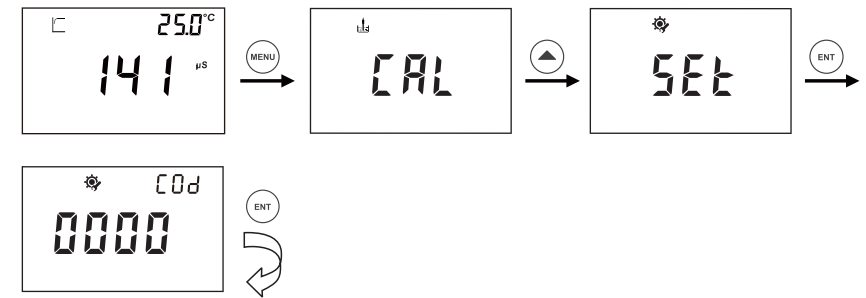

- In measurement mode, press **MENU** key to enter calibration step, and then, press ▲ key to enter set up process.
- Press **ENT** key to pass through, if you have not set up password.

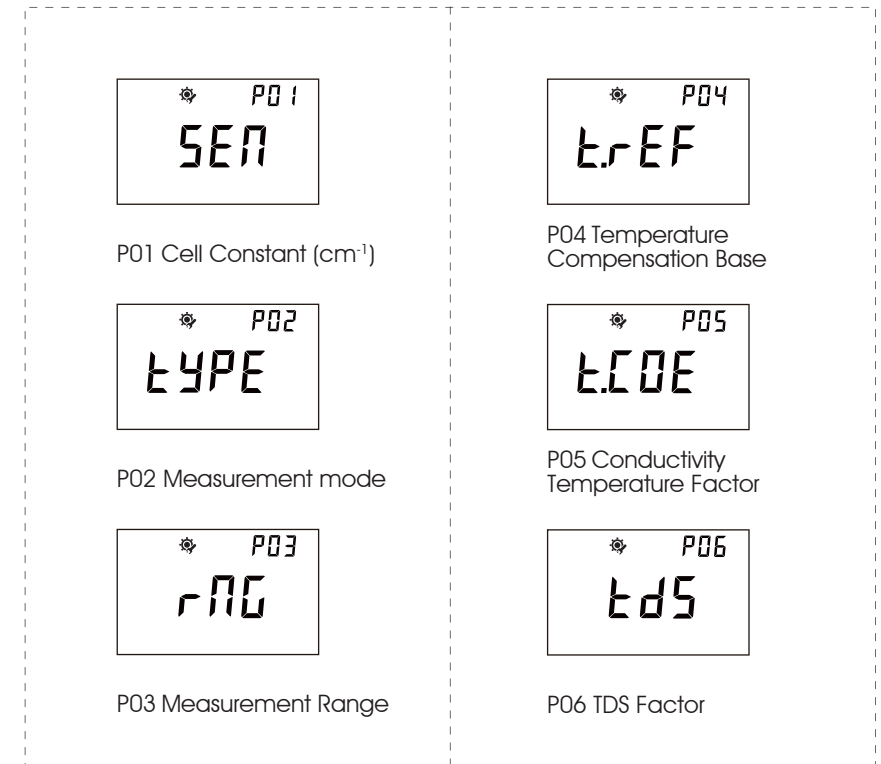



P07 Salinity Factor



P08 Temperature Input & Offset

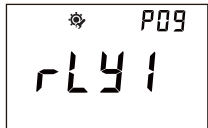

P09 Relay 1 (SP1)

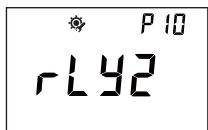

P10 Relay 2 (SP2)

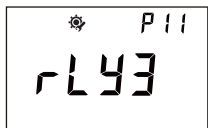

P11 Relay 3 (SP3)
Only for 5000/5500



P12 Current Output

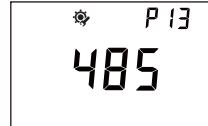

P13 RS485 Output
Only for 5000/5500



P14 Password

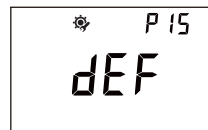

P15 Factory Defaults

5.14 P14 Password

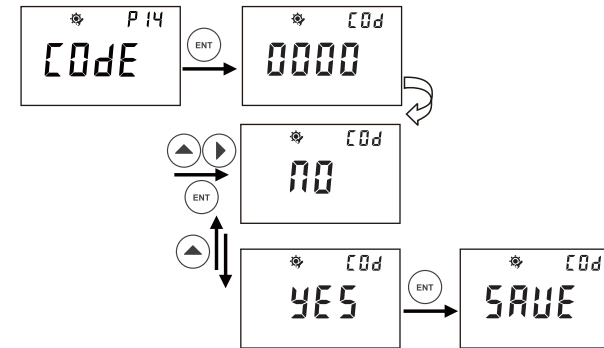

- In P-14, you can set up password method to prevent anyone from changing your settings.
- Please refer to above description steps to set up P-14
- You can go to next parameter setting by pressing ▲ ►, or press MENU key to quit and go back to measurement mode.
- Factory default: 0000

5.15 P15 Factory Defaults

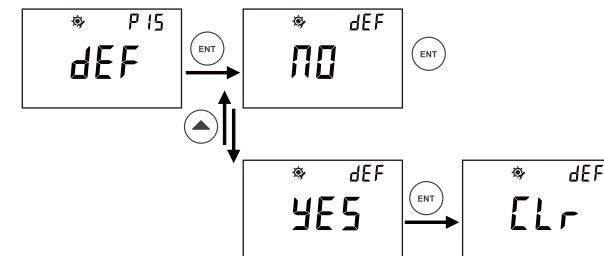

- In P-15, you can select to change factory defaults or to revert to factory default status.
- Please refer to above description steps to set up P-15
- You can go to next parameter setting by pressing ▲ ►, or press MENU key to quit and go back to measurement mode.

5.12 P12 Current Output

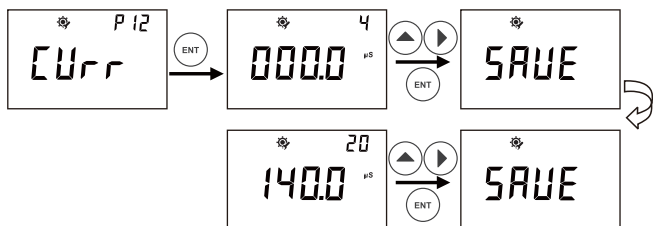

- In P-12, you can set up current output / transmitting for measurement valve for advanced application.
- After entering P-12, the figure 4 on top right corner represents transmitting 4 mA out for below set value (000.0%).
- (000.0%), you can press ▲ ► to set a specific value you need to transmit 4 mA for your application.
- The figures 20 on top right corner represent transmitting 20 mA out for below set value (140.0%).
- The pH range for setting is from 000.0 to 140.0%.
- Please refer to above description steps to set up P-12
- You can go to next parameter setting by pressing ▲ ► or press MENU key to quit and go back to measurement mode.

5.13 P13 RS485 Output Only in 5000/5500

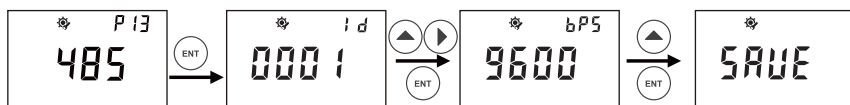

1. After entering P-13, you can press ▲ ► to set the ID of the protocol address and press ENT to confirm. ID range can be set from 01 to 200.
2. You can press ▲ to set the protocol rate you need and confirm by pressing ENT.

3 INSTALLATION

3.1 Installation

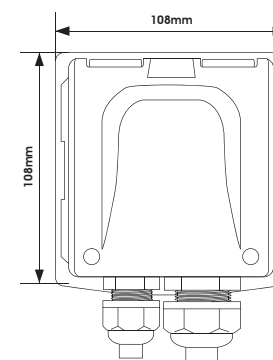
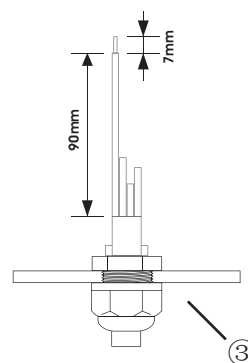
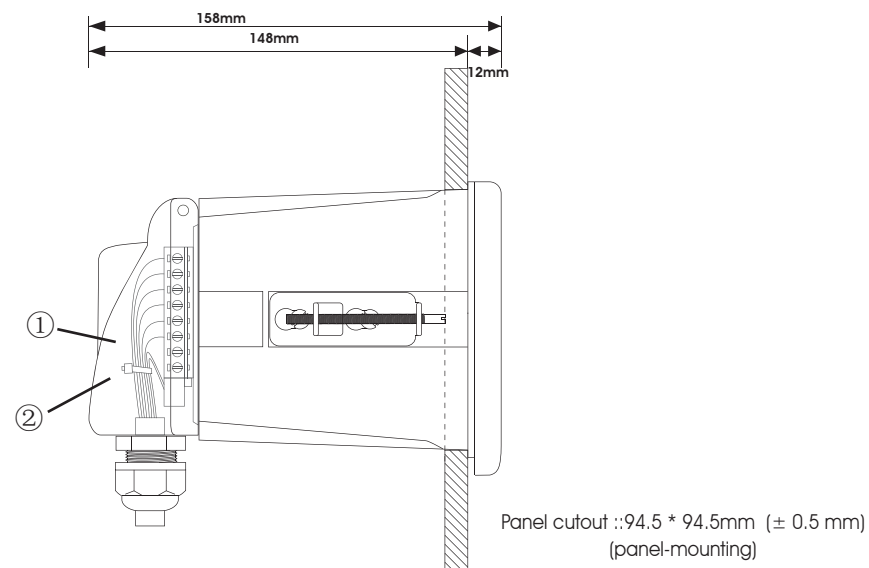

- ①. Cable (Recommended stripping length for cables is at least 90mm, please use 0.5 to 1 square meter's wire)
- ②. Cable ties
- ③. Waterproof cable glands

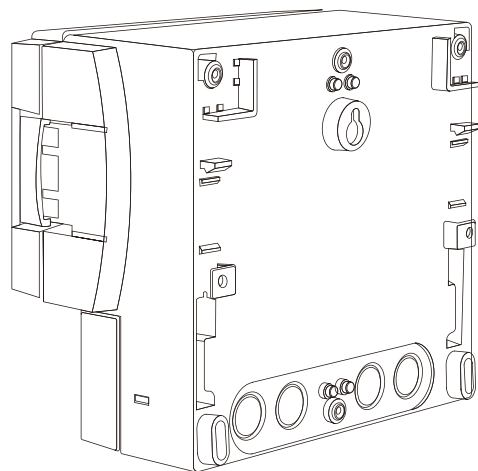
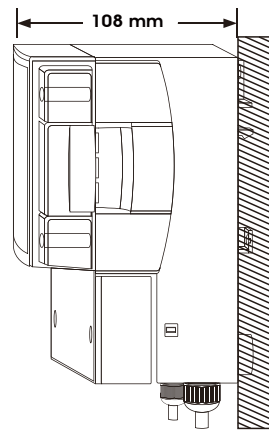
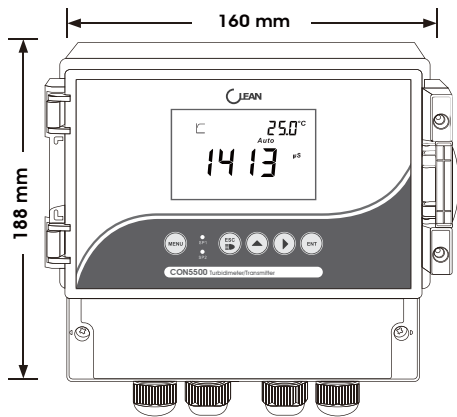

5.11 P11 Relay 3 (SP3) Only for 5000/5500

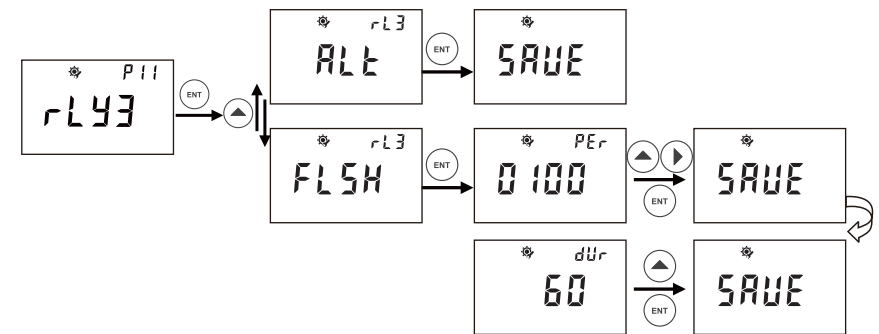

- In P-11, you can set up Relay 3 (SP3), also called the Cleaning/Alarm Relay.
- After entering P-11, you can press ▲ to set the ALT and FLSH.
- By pressing ENT to set the ALT function, the unit will then alarm if the other two Relays have any operation.
- FLSH refers to the Cleaning function. The cleaning frequency can be set per each 0-1000hours and 0-120 seconds for the time of duration.
- You can press ▲ ► to set the specific hours you need to clean per each time. Press ▲ to set the duration time per each cleaning.
- Please refer to above description steps to set up P-11.

Note: The Cleaning/Alarm Relay can also be set as manual in the measuring mode as below:

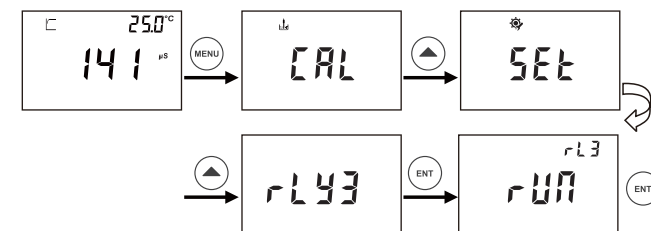

- After entering the measuring mode, the screen will twinkle and display "RUN". The twinkling will stop by pressing ENT and the unit starts to clean/alarm. This function is only available for the current model.

5.9 P09 Relay 1 (SP1)

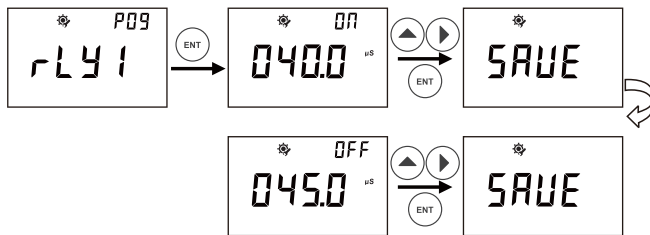

- In P-09, you can set up Relay 1 (SP1): ON-Point and OFF-Point.
- Please refer to above description steps to set up P-09.
- You can go to next parameter setting by pressing ▲ ►, or press **MENU** key to quit and go back to measurement mode.

5.10 P10 Relay 2 (SP2)

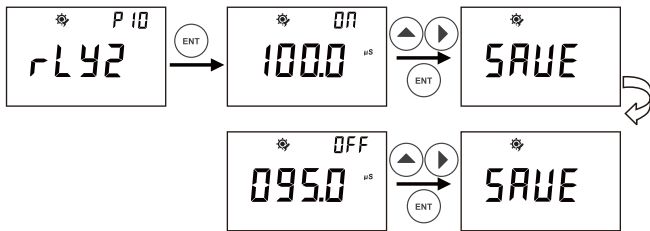

- P-10, the same procedure as P-09.

3.2 Connection Diagram

CON2000 Connection Diagram

Terminal	Function	Terminal	Function
PD	Pt1000 drive positive	TP+	4-20mA output, positive
PT+	Pt1000 signal positive	TP-	4-20mA output, negative
PT-	Pt1000 signal negative	I+	240VDC(positive)
T1	T1	I-	240VDC(negative)
T2	T2	COM	
		PH-	

CON3000/CON5000 Connection Diagram

Terminal	Function	Terminal	Function
PD	Pt1000 drive positive	COM(RL2)	COM(RL2)
PT+	Pt1000 signal positive	OPEN(RL2)	OPEN(RL2)
PT-	Pt1000 signal negative	COM(RL3)	COM(RL3)
T1	T1	OPEN(RL3)	OPEN(RL3)
T2	T2	4-20mA (positive)	4-20mA output, positive
SEN+	Sensor +	4-20mA(negative)	4-20mA output, negative
SEN-	Sensor -	485(B)	485 output
COM		485(A)	485 output
COM(RL1)	COM(RL1)	L	Line
OPEN(RL1)	OPEN(RL1)	N	Neutral
		⊕	Earth

CON5500 Connection Diagram

Terminal	Function	Terminal	Function
S2	Sensor - [Positive]	B	485 output
S1	Sensor + [Negative]	A	485 output
COM	COM	R3	COM(RL3)
PD	Pt1000 drive positive	R3	OPEN(RL3)
PT+	Pt1000 signal positive	R2	COM(RL2)
PT-	Pt1000 signal negative	R2	OPEN(RL2)
T1	NTC22K input	R1	COM(RL1)
T2	NTC22K input	R1	OPEN(RL1)
I+	4-20mA output, positive	FG	Earth
I-	4-20mA output, negative	FG	Earth
		N	Neutral
		L	Live

* For 2-wire Pt1000 temperature sensing terminal system, use short circuit between PD and PT+.

4 CALIBRATION

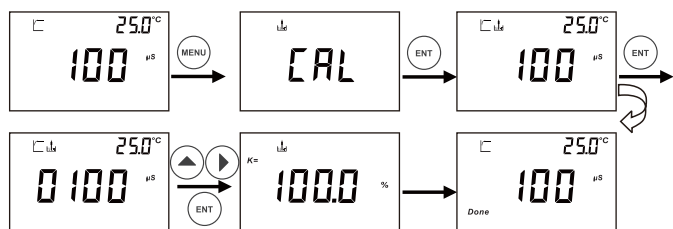

- In measurement mode, press **MENU** key to enter calibration mode.
- Dip the electrode into standard solution, then press **ENT** to start calibration.
- After you get a stable current value, Press **▲ ►** to adjust the value figures to match with the standard solution, then press **ENT** to finish calibration process.
- The value of cell constant K indicate the status of the electrode.

5.8 P08 Temperature Input & Offset

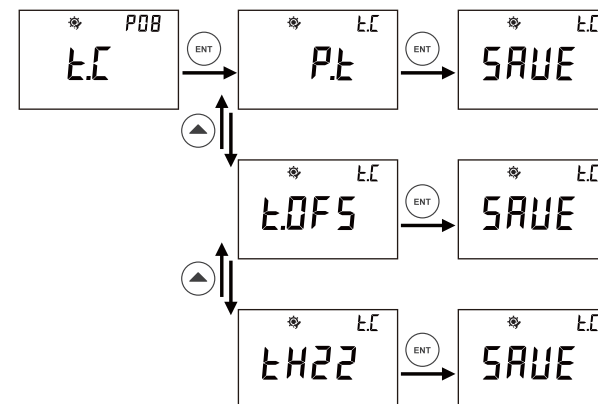

- In P-08, you can complete 2 temperature related settings:
 - 1, set up temperature sensor type.
 - 2, set up temperature offset value.
- Please refer to above description steps to set up P-03.
- You can go to next parameter setting by pressing **▲ ►**, or press **MENU** key to quit and go back to measurement mode.

5.6 P06 TDS Factor



- In P-06, you can set TDS factor for your application.
- Please refer to above description steps to setup P-06.
Factory default: 0.50
- You can go to next parameter setting by pressing ▲ ►, or press **MENU** key to quit and go back to measurement mode.

5.7 P07 Salinity Factor



- In P-07, you can set Salinity factor for your application.
- The range for salinity factor is from 0.48 to 0.65.
- Please refer to above description steps to set up P-07.
Factory default: 0.65
- You can go to next parameter setting by pressing ▲ ►, or press **MENU** key to quit and go back to measurement mode.

5 SET UP

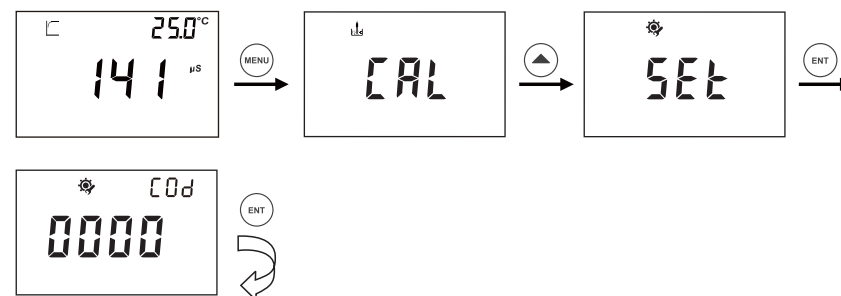

- In measurement mode, press **MENU** key to enter pH calibration step, and press ▲ to enter **SET** UP step, then press **ENT** key to enter set up process.

5.1 P01 Cell Constant (cm⁻¹)

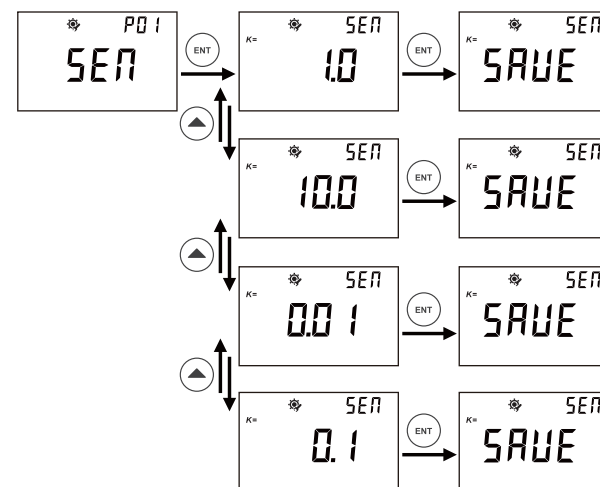

- In P-01, you can set up cell constant K of your sensor for measurement application.
- Please refer to above description steps to setup P-01.
- You can go to next parameter setting by pressing ▲ ►, or press **MENU** key to quit and go back to measurement mode.
- Factory default: 1.0

5.2 P02 Measurement mode

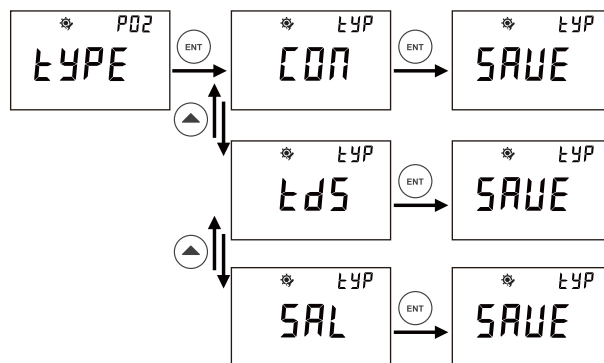

- In P-02,you can set up conductivity or TDS or Salinity as unit for your application.
- Please refer to above description steps to setup P-02.
- You can go to next parameter setting by pressing ▲ ► ,or press **MENU** key to quit and go back to measurement mode.

5.3 P03 Measurement Range

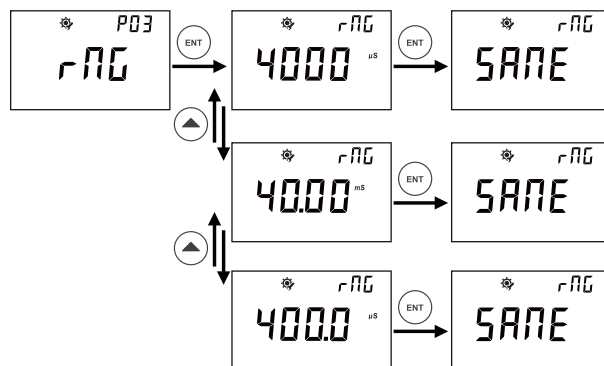

- In P-03,you can set up conductivity measurement range for your application.
- Please refer to above description steps to setup P-03.
- You can go to next parameter setting by pressing ▲ ► ,or press **MENU** key to quit and go back to measurement mode.

5.4 P04 Temperature Compensation Base



- In P-04,you can set system temperature base value for conductivity measurement.
- Please refer to above description steps to setup P-04.
- You can go to next parameter setting by pressing ▲ ► ,or press **MENU** key to quit and go back to measurement mode.
- Factory default: 25°C

5.5 P05 Conductivity Temperature Factor



- In P-05,you can set Temperature coefficient for conductivity.
- Please refer to above description steps to setup P-05.
- You can go to next parameter setting by pressing ▲ ► ,or press **MENU** key to quit and go back to measurement mode.
- Factory default: 2.00%